

# XR200

## X-RAY GENERATOR

# OPERATOR'S MANUAL



 **Golden Engineering**  
*Portable X-ray Technology*

# CONTENTS

ITEM	PAGE
1.0 INTRODUCTION.....	2
2.0 WARNINGS.....	2
DUTY CYCLE .....	2
STORAGE .....	2
3.0 PHYSICAL DESCRIPTION.....	3
HIGH VOLTAGE PULSER/TUBEHEAD.....	3
BASE.....	3
BATTERY CHARGER.....	3
CONTROL MODULE.....	4
CABLE CONNECTOR DIAGRAM.....	5
4.0 DESCRIPTION OF OPERATION.....	6
BLOCK DIAGRAM.....	6
5.0 <b>OPERATING INSTRUCTIONS</b> .....	<b>7</b>
OPERATING PRECAUTIONS.....	7
EXCLUSION ZONE.....	7
PULSE SELECTION .....	7
REMOTE CABLE OPTION.....	8
DELAY MODE OPTION.....	8
REAL TIME IMAGING OPTION.....	8
PULSE SETTINGS.....	8
6.0 SOFTWARE.....	9
7.0 MAINTENANCE.....	9
DOSE MEASUREMENT.....	9
TUBE REPLACEMENT.....	9
8.0 TROUBLE-SHOOTING.....	10
9.0 INSTRUCTIONS FOR REPAIR.....	10
HANDLE REPLACEMENT.....	10
FUSE REPLACEMENT.....	11
REMOVING BOARDS.....	11
BOARD INSTALLATION.....	11
HEAD REPLACEMENT.....	12
BATTERY DISPOSAL.....	12
10.0 WARRANTY.....	13
<b>RETURNING REPAIR INSTRUCTIONS</b> .....	<b>13</b>
11.0 SPECIFICATIONS.....	14
PHYSICAL DIMENSIONS.....	14
X-RAY OUTPUT.....	14
ELECTRICAL & THERMAL CHARACTERISTICS.....	14
12.0 SPARE PARTS.....	14

## 1.0 INTRODUCTION

**The XR200 produces high levels of radiation and must be operated by qualified personnel who have read the Warning and Operations section of the manual before operating the device.**

The XR200 is a small, lightweight x-ray generator that operates on its own removable battery pack. The XR200 is a pulsed x-ray device that produces x-ray pulses of very short duration (50 nanoseconds). It produces a low dose rate comparable to a 0.5 ma constant potential machine. The energy produced by the XR200 is up to 150KVP, which makes it possible to radiograph up to one (1/2) inch (1 cm) of steel.

XR200 standard accessories are two keys, two battery packs, and one battery charger. Remote cable, carrying case, and film developing equipment are also common accessories.

## 2.0 WARNINGS

The XR200 is a pulsed X-ray generator that emits hazardous ionizing radiation when pulsing. The XR200 should only be **operated** by **authorized personnel** who are properly trained to safely operate the generator. The XR200 must be **registered** with proper authorities prior to use and should **not** be used to intentionally expose humans.

Develop and closely follow a safe operating system for using the XR200. The safe operating system must ensure that no one is exposed to radiation above the permissible limits which are 2 mR (0.02 mSv) per hour for a member of the public. ***The safe operating system must ensure the XR200 is used within federal and state guidelines.***

All operators and users of the XR200 x-ray machine must wear a personal radiation monitoring device, such as a TLD (thermo luminescent dosimeter), film badge, and/or a pocket dosimeter **consistent with the appropriate federal, territorial or provincial standards** (note: an electronic dosimeter will not detect the XR200 radiation pulses).

Due to the short pulse width of the XR200, survey meters of the Geiger-Mueller and scintillator type do not accurately detect the radiation emitted from the x-ray source.

***Survey meters should be of the ionization type and should be used in the integration mode.*** Survey meters must not be used in the rate mode because the XR200 does not produce constant radiation. The XR200 produces very high rates of radiation for very short periods of time resulting in either unrealistically high readings or no readings for a survey meter in rate mode.

**The XR200 has no explosion proof rating and should not be used in an explosive atmosphere. The Spark Gap is vented to the air and could be a source of ignition.**

**DUTY CYCLE WARNING.** *The XR200 is a light duty machine that is not made to pulse continuously.* The maximum duty cycle for the XR200 is 200 pulses every four minutes (3000 pulses per hour). Two consecutive pulse trains of 99 pulses can be fired then the unit should rest at least four minutes. Exceeding the duty cycle will shorten the life of the tube and head.

**STORAGE & USE: Store and use the XR200 in upright position.** Upside down storage or use may cause premature failure including no output dose.

### 3.0 PHYSICAL DESCRIPTION

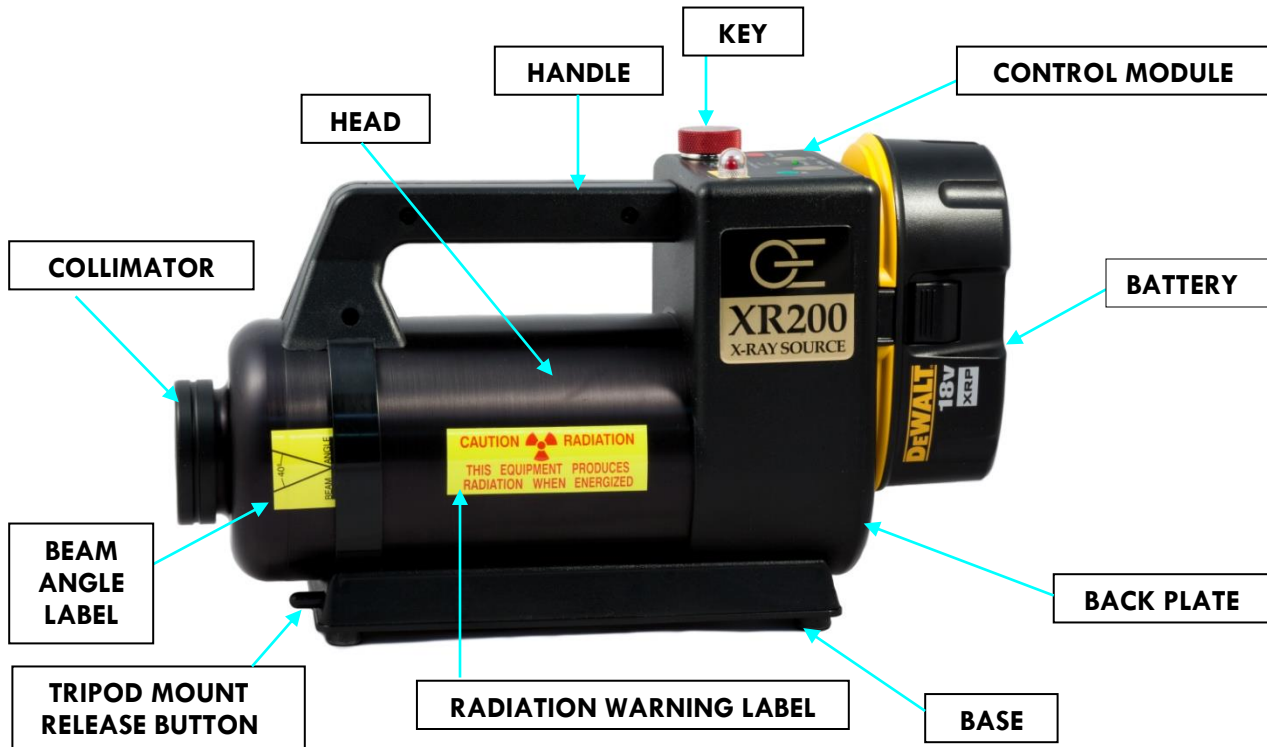

Figure 1: XR200 X-ray Unit

**HIGH VOLTAGE PULSER/TUBEHEAD.** The main body of the XR200 is the tube head which contains the tube cavity, cold cathode type X-ray tube, spark gap, high voltage capacitor, and transformer. The standard collimator located on the front of the head limits the X-ray beam to 40 degrees. Special order collimators up to 85 degrees are available.

**BASE.** The base of the XR200 contains the base plate, tripod mount, tripod mount release button, and identification label. The tripod mount contains threaded  $\frac{1}{4}$ -20 insert that can be attached to any standard camera tripod. Press the release button to remove the tripod mount from the base. A label identifying the model, manufacturer, and serial number is located on the bottom of the XR200 base.

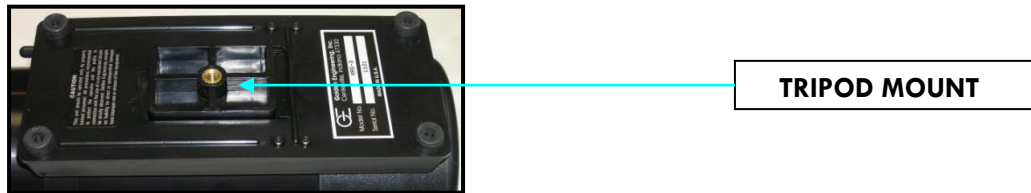

Figure 2: Base

**BATTERY PACK.** The standard battery pack is a DeWalt® 18v nickel-cadmium battery. Optional battery chemistry or voltage may be available.

**BATTERY CHARGER:** The standard battery charger is the DeWalt® DW9116 110V charger or DE9108 220V charger. Battery charge time is one hour. See battery charger manual for additional instructions and warnings.

### 3.5 CONTROL MODULE



Figure 3: Control Module

**POWER ON LIGHT:** Illuminates when battery voltage is applied to control module.

**RED X-RAY PULSING LIGHT:** Blinks after time delay button or remote cable button is pressed to warn that the XR200 is going to pulse. The light stays on continuously while the XR200 is pulsing. This is a failsafe warning light. **If the light does not work the X-ray unit will not pulse.**

**LIQUID CRYSTAL DISPLAY (LCD):** Two digit LCD displays selected pulse, time before unit pulses, software version, and total number of pulses on the unit.

**RANGE SWITCH:** Used to alternate LCD between tens digit and one's digit.

**UNITS SWITCH:** Used to change the value of the tens digit or units digit from 0 to 9. The UNITS SWITCH is also used with the EMERGENCY STOP SWITCH to alter the default pulse setting.

**DELAY SWITCH:** Initiates delay mode.

**EMERGENCY STOP SWITCH:** Stops the unit before it begins pulsing or stops the unit in the middle of a pulse train. This switch can also be pressed **with** the UNITS SWITCH to alter the default pulse setting when the XR200 is first powered up.

**CABLE CONNECTOR:** Lemo connector located on the back of the control module beneath the battery receives the remote cable or imaging system cable. See Rear View Diagram on page 5 for details.

**BACK PLATE:** Covers the Oscillator board and contains battery terminal connectors.



# XR200 REAR VIEW/CABLE CONNECTOR

PIN #	DESCRIPTION
1	+5 VOLTS 100 ma MAXIMUM
2	REMOTE SWITCH
3	REMOTE SWITCH – NO DELAY
4	X-RAY ON SIGNAL
5	COMMON 0 VOLTS

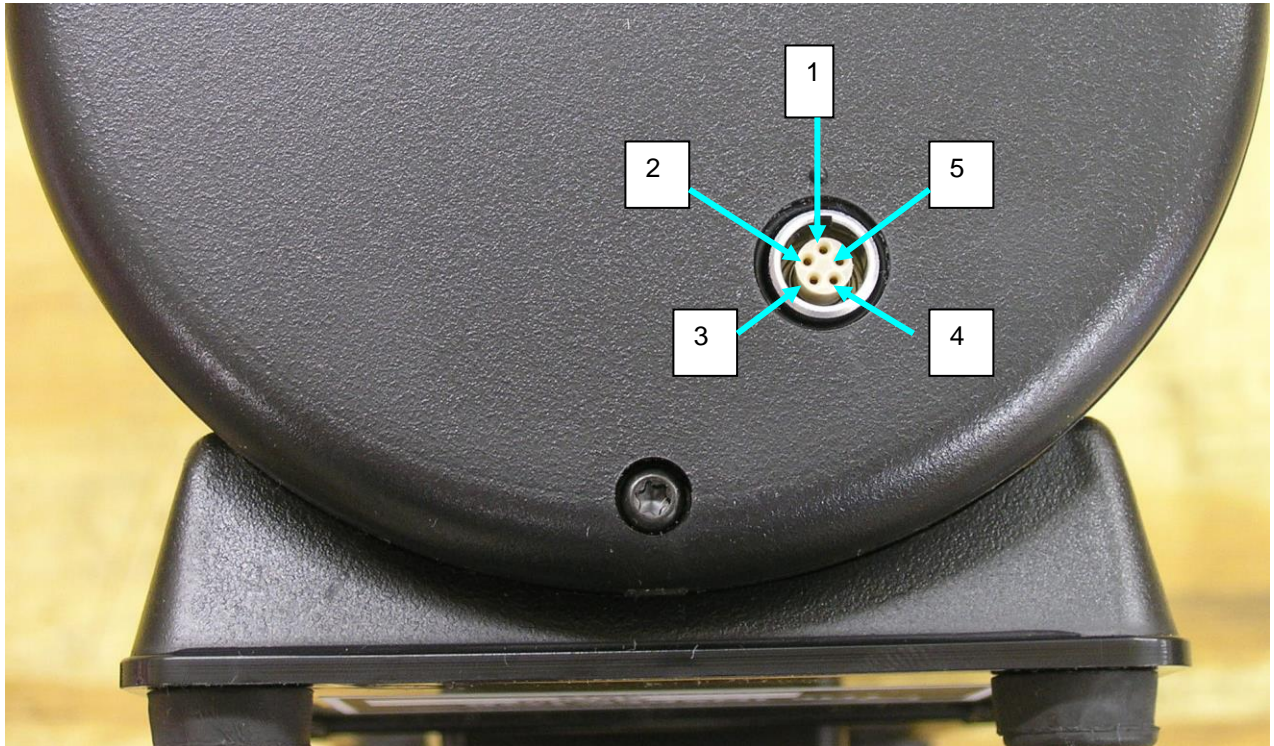

REMOTE CONNECTOR:  
MATING CABLE PLUG:

LEMO EPG.0B.305.HLN  
LEMO FGG.0B.305.CLAD 56Z

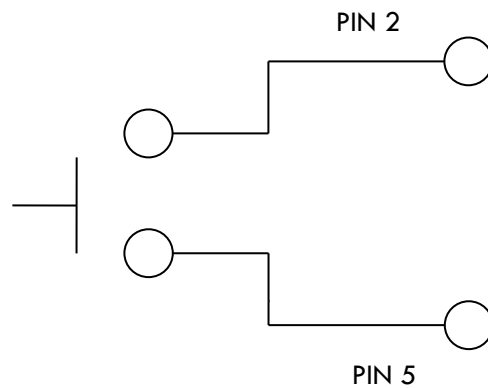

Remote switch inputs are activated when grounded.

## 4.0 DESCRIPTION OF OPERATION

The block diagram below illustrates how the XR200 functions. The following sequence of events takes place each time the XR200 is fired:

1. User initiates operation of the machine.
2. The control section sends a signal to the converter section to begin oscillating.
3. Once oscillating, the converter section changes the 18 volts DC to 22Khz AC.
4. The transformer charges the High Voltage Capacitor to about 8000 volts.
5. The spark gap arcs after the High Voltage Capacitor reaches proper voltage.
6. The pulse detector signals the control block that the unit has pulsed.
7. As the High Voltage Switch is closed, a high voltage transient of approximately 150,000 volts and 50 nanoseconds in duration is applied across the x-ray tube generating x-rays.

The closing of the High Voltage Switch produces an audible pulsing sound. **The XR200 cannot produce x-rays without the pulsing sound so it serves as an additional warning the XR200 is functioning.**

This unit generates x-rays through high voltage bombardment of a tungsten target. **The XR200 does not contain radioactive materials.** All the high voltage is contained within the aluminum canister and as long as the canister is not punctured the operator is not exposed to dangerous voltages.

### BLOCK DIAGRAM

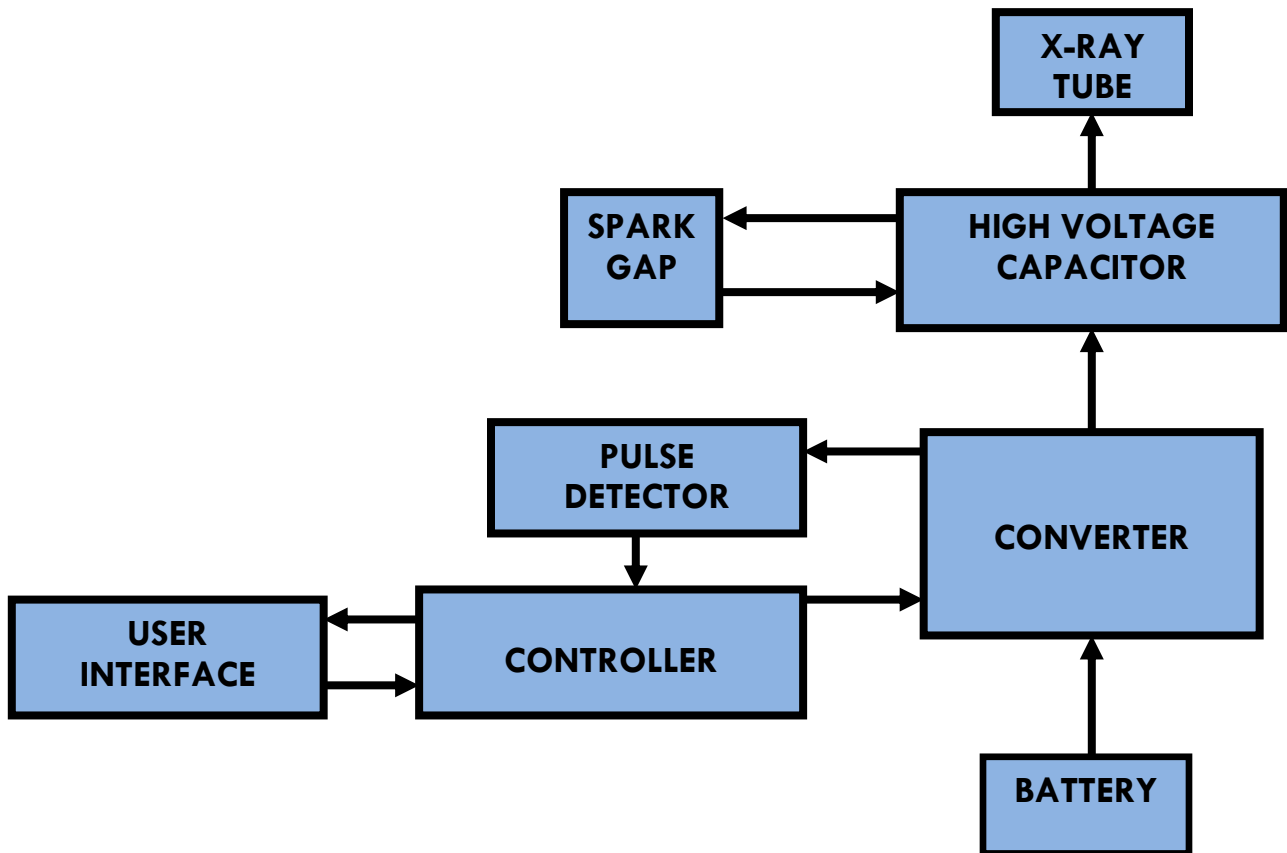

## 5.0 OPERATING INSTRUCTIONS

**OPERATING PRECAUTIONS:** The operator should always stand at least 10 feet behind the X-ray unit and clear all personnel at least 10 feet behind the unit or at least 100 ft. from the front of the unit before pulsing. The exclusion zone (below) should be a controlled area free of all personnel while X-ray pulses.

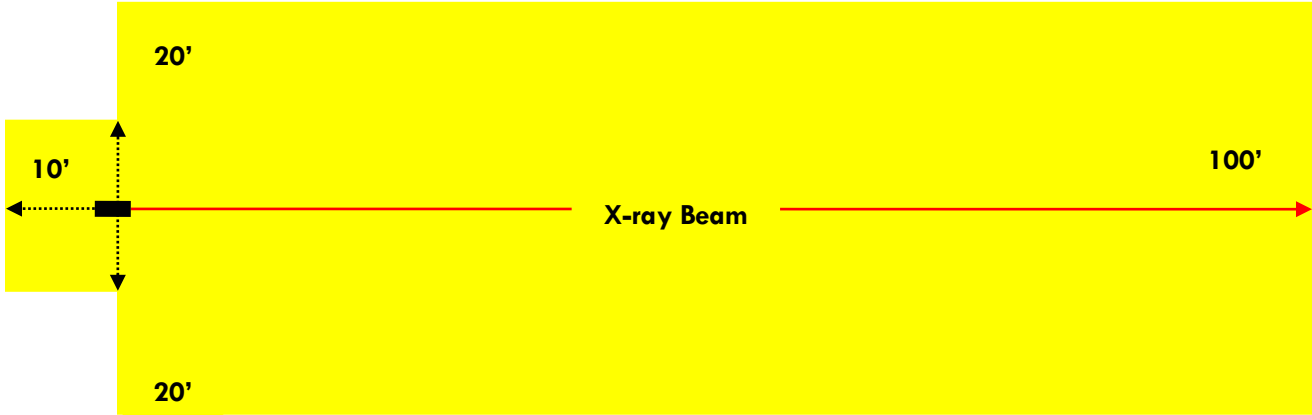

Figure 4: Exclusion Zone

### PULSE SELECTION

1. **Attach** a charged battery and **turn on** the X-ray generator.
2. **Press** the RANGE BUTTON. The one's digit of the LCD will blink twice and then go blank.
3. **Press** the UNITS BUTTON to adjust the ones digit from 0 to 9.
4. **Press** the RANGE BUTTON again and the tens digit of the LCD will blink twice and go blank.
5. **Press** the UNITS BUTTON to change the tens digit from 0 to 9.
6. **Press** the RANGE or UNITS BUTTON again to accept the new pulse setting.
7. Both tens digit and units digit will blink to indicate acceptance of the new pulse setting. (If RANGE or UNITS BUTTON is not selected after entering the pulse count the generator will automatically accept the entered pulse setting after six seconds).
8. **Press** the UNITS BUTTON and EMERGENCY STOP BUTTON simultaneously to **lock in** pulse setting. If XR200 is turned off and back on new pulse setting will appear on LCD.



Select ones digit

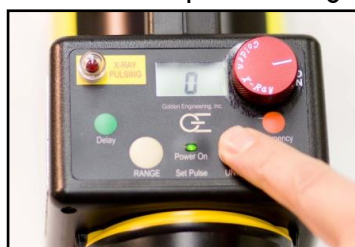

Enter ones value (0-9)



Select tens digit



Enter tens value (0-9)



Change pulse default (optional)



### DELAY MODE OPTION

1. **Press** Green DELAY BUTTON on top of the control module.
2. LCD displays 60 and X-ray begins 60 second time delay.
3. **Hold** DELAY BUTTON down for 1.5 seconds and time delay goes from 60 to 15 seconds.
4. X-ray makes audible beep and red pulsing light blinks as generator counts down to pulse.
5. Audible warning and red warning light stay on while X-ray pulses.

### REMOTE CABLE OPTION

1. **Attach** remote cable to back of control module.
2. **Retreat** distance of the cable behind the unit.
3. **Press and hold down** remote cable firing button until X-ray generator completes pulse train.
4. There are audible beeps and red pulsing light blinks during a **5 second safety delay**.
5. Audible warning and red pulsing light stay on while X-ray pulses.

### REAL TIME IMAGING OPTION

1. **Change** pulse setting default to 99 pulses if it is not already set to 99 pulses.
2. **Attach** imager cable to back of the control module unless using wireless option.
3. **Refer** to imaging system instructions for details on pulse setting and pulsing the generator.
4. There is **no** delay in this mode so the X-ray generator will pulse immediately unless there is a time delay on the imaging system.

### SUGGESTED PULSE SETTINGS

The chart below lists **approximate** pulses necessary to penetrate various materials. Settings vary greatly depending on imaging system used. Refer to imaging system instructions for more information.

MATERIAL	PULSE SETTING 24 inches between x-ray & imager
CARDBOARD / LIGHT WOOD / PLASTIC	2-5
LIGHT METAL	10
STEEL 1/4"	25
STEEL 1/2"	50
STEEL 1"	99
BRASS 1/8" to 1/4"	50- 99

The following is true when using film or digital systems that generate a positive image. If the radiograph is too dark, the film is underexposed. If the radiograph is too light the film is overexposed. **Underexposure** can be corrected by increasing the number of pulses and/or decreasing the distance between the imaging medium and the XR200. **Overexposure** can be corrected by reducing the number of pulses and/or increasing the distance between the imaging medium and XR200.

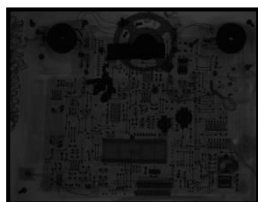

Underexposed

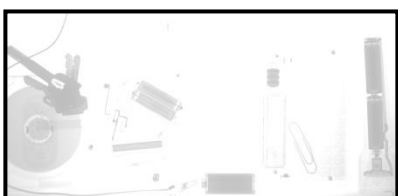

Overexposed

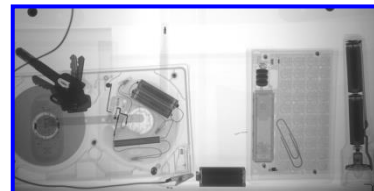
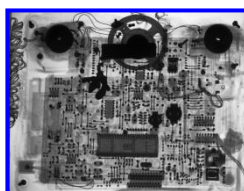

Correct exposures (pulse setting)

## 6.0 SOFTWARE

The software program that controls the microcontroller can be identified by turning the key switch on while both push button switches (RANGE & UNITS) below the LCD are depressed. The LCD displays the software version "65". After "65" is displayed the total number of pulses on the XR200 will be displayed in the LCD. Each digit represents 10,000 pulses. Example: If the LCD reads "04" the total number of pulses on the XR200 is between 40,000 and 50,000 pulses. After the total number of pulses is displayed the LCD will read "00" or the default pulse setting that was last stored on the unit.

The software program is capable of determining the state of battery charge based on the time between each pulse. As the battery loses charge the XR200 pulse rate slows, with more time between each pulse. If there is more than 0.33 seconds between two consecutive pulses the following will occur:

- The XR200 continues the current pulse train to "00".
- After the XR200 stops pulsing. The LCD goes back to the original pulse setting. The left and right digits blink alternately.
- The condition indicates a low battery.
- The XR200 will be inoperable until the key switch is turned off and on, or the battery is replaced.

If there is more than one second between two consecutive pulses:

- The XR200 stops pulsing immediately and the LCD displays 00.
- This function prevents XR200 from pulsing continuously if there is a failure in detecting circuitry.
- This condition may indicate a low battery, electrical noise, or failure in detecting circuitry.
- The operator may need to replace the battery pack, turn key switch off and on, or send the XR200 back for repair.

## 7.0 MAINTENANCE

**X-RAY DOSE MEASUREMENT** Using a dosimeter, the average X-ray dose for new tube can be established.

- With the dosimeter located 1 foot from the front of the case and in line with the center of the beam angle label, the reading for 10 pulses should be 26 mR to 36 mR.
- The leakage sheet illustrates the X-ray dose and maximum allowable radiation leakage levels for each X-ray unit. A completed copy of this form accompanies each X-ray.

**TUBE REPLACEMENT:** The XR200 tube should last at least 100,000 pulses. Under normal conditions the tube's output will decrease slowly with use. If the tube is broken or glass cracks the tube output will cease immediately. The following are tube replacement instructions.

1. Remove the battery before unscrewing the collimator. **WARNING! There is a potential of electric shock if the battery is not removed before unscrewing the collimator.**
2. To replace the tube unscrew the collimator.
3. Using needle nose pliers or your fingers grab the front of the tube and pull straight out.



## 8.0 TROUBLESHOOTING

SYMPTOM	TEST	ACTION
No "power on" light	-Check battery voltage -Check battery connection	- Replace or charge battery - Make sure battery is securely attached and battery clips are not bent or broken.
Power on lights, but X-ray does not pulse.	-Check the battery voltage. -Check the 2amp fuse.	-Charge or replace the battery. -Replace the fuse if necessary.
Power on lights, X-ray pulsing light does not illuminate, X-ray dose not pulse		- Replace the X-ray pulsing light
X-ray pulses, but no image or black image.	-Test X-ray output.	-Replace the tube.
Unit stops pulsing in the middle of a pulse train and LCD displays 00.	-Check the battery voltage. -Check 15 amp fuse. -Check feedback line connection.	- Charge battery if necessary. - Replace the fuse if blown. - Make sure the screw holding wire to the oscillator board.
Unit makes loud popping noise while pulsing.		- <b>Stop immediately and return for repair.</b>
Oil leaking from unit.		Return for repair.

## 9.0 INSTRUCTIONS FOR REPAIR

### HANDLE REPLACEMENT Requires T-10 torx driver.

The Handle has two sides that are screwed together. Three screws in the handle hold it together and one screw in the base holds the handle strap together under the head.

1. Remove the 3 screws on the side of the handle.
2. Remove the base plate on the bottom of the unit.
3. Remove the screw on the bottom of the unit that holds the handle strap together.

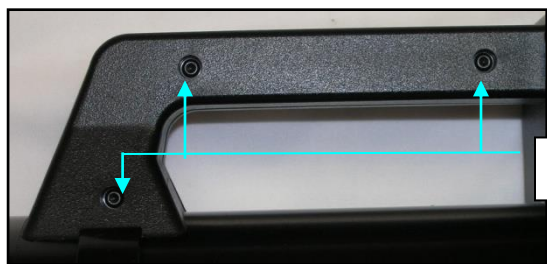

Figure 5: Handle

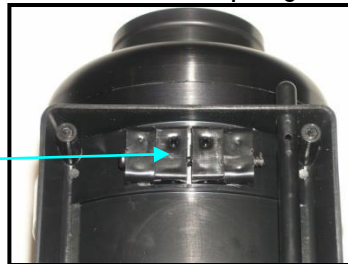

Figure 6: Handle strap base

4. Remove the half of the handle that is broken.
5. Place a small amount of glue on the protrusion from the control module.
6. Install new half of the handle.
7. Insert and tighten 3 screws in the handle and one screw in the handle strap. **Do not over tighten the screw in the handle strap (bottom) as this will crack the strap.**
8. Attach the base plate and insert all the screws that hold it in place.

**FUSE REPLACEMENT** Requires T-10 Torx driver & needle nose pliers.

1. Remove the back plate. Remove the 5 screws in the back plate then pull the back plate off slowly maneuvering the battery terminal connecting wires through the opening in the oscillator board.
2. The 20 amp fuse is the white one inch long fuse on the left side of the oscillator board. The 2 amp fuse is a small green fuse just to the right of the 20 amp fuse. See diagram on page 12. The 20 amp fuse can be removed with fingers. The 2 amp fuse may require needle nose pliers to pull it out of the board. It should be pulled in a downward direction to remove from the board.

**REMOVING THE BOARDS** Refer to the diagram on page 12 for steps 1-4.

1. Remove the back plate (see FUSE REPLACEMENT step 1). After the terminals are through the oscillator board, disconnect the red and black battery wires.
2. There are three terminals on the lower left side of the oscillator board and one on the lower right. Disconnect the two blue wires, one red wire, and one green signal wire using Philips head screw driver.
3. There are three socket head cap screws holding the oscillator board in place. Two are in the middle of the board and one is at the bottom. Remove these three screws. Be aware of the 1/2 inch stand offs behind the oscillator board.
4. Remove the flat head screw in the upper left side of the oscillator board between the two fuses.
5. Pull the board out.
6. Disconnect the oscillator board from the counter board by pulling the bottom of the oscillator board up and away from the counter board. Disconnect the two pin white key switch connector, white three pin remote connector and black touch pad connector.
7. Unscrew the LED bulb cover on the X-ray on LED.
8. Tilt the back of the counter board down until the LED clears the housing then pull the board out of the housing.

**BOARD INSTALLATION**

1. Slide counter board back into the top of the Control module housing just below the screw receptacles.
2. Push the counter board up so LED goes through the appropriate hole in the control module housing.
3. Connect the three white and one black connector.
4. Screw the LED cover back on.
5. Put the three cap screws through the oscillator board and then put the 1/2" offsets on the back of the screws.
6. Plug the oscillator board back into the counter board and push it in position.
7. Tighten the three screws holding the board in place.
8. Insert the flat head screw in upper left corner of the Oscillator board.
9. Attach the two blue wires, one red wire, and green signal line.
10. Reinstall the back plate.

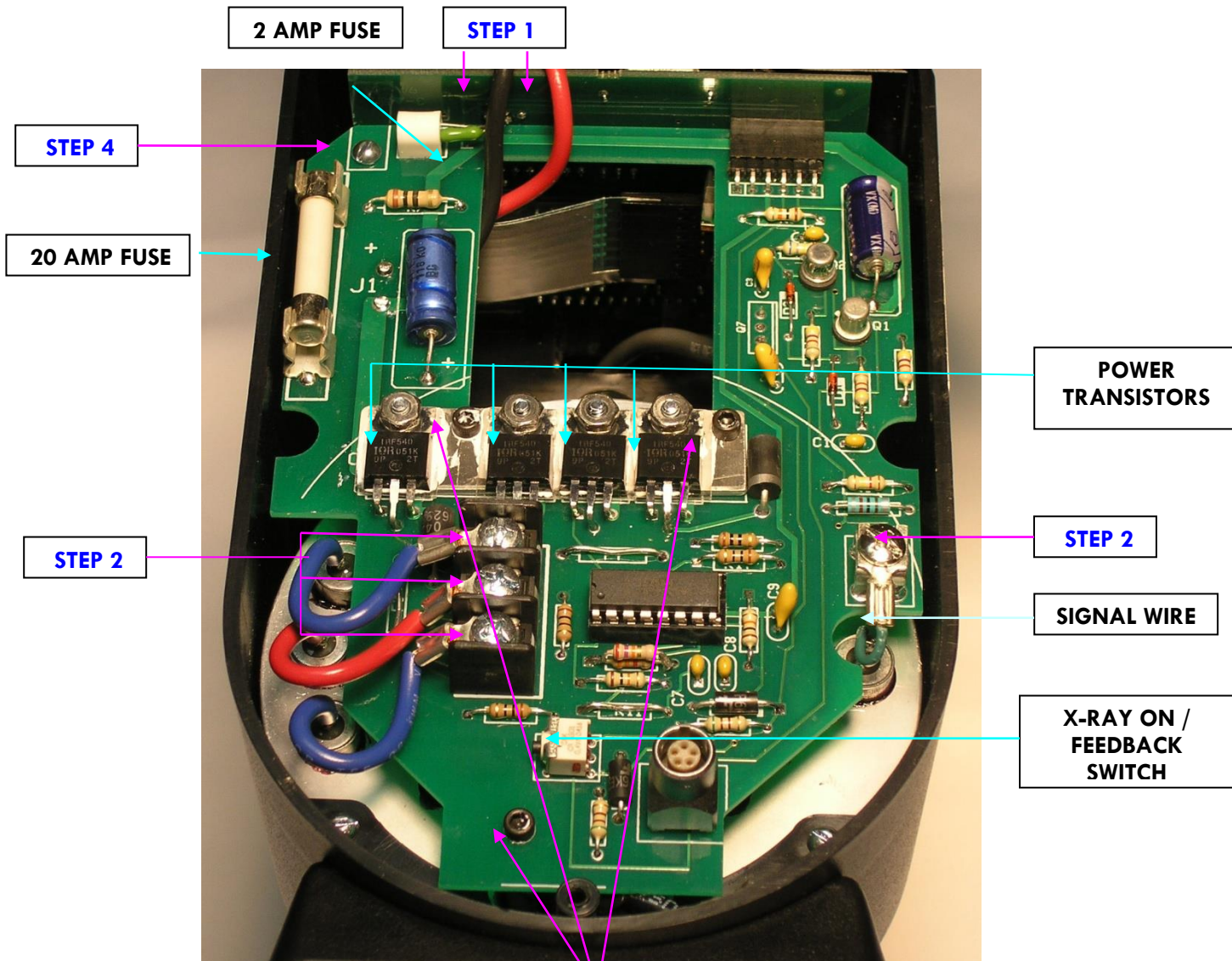

Figure 7: Oscillator Board

STEP 3

**HEAD REPLACEMENT** Requires a small flat head screw driver.

1. Remove the boards as instructed above.
2. Remove the two screws on the bottom that attach the head to the control module.
3. Remove the screw on the upper left side of the head. Must rotate head slightly and put the screw driver through the left LED hole to remove the screw.
4. Pull the head straight out of the control module. You might need to loosen the screw in the handle to get the head out.

**INSTRUCTIONS FOR BATTERY DISPOSAL** Follow all federal, state, and local laws for disposal of nickel-cadmium batteries. Batteries may be returned to Golden Engineering for disposal.



## 10.0 WARRANTY

Golden Engineering, Inc. warrants XR200 X-ray unit made and sold by it or its authorized representatives to be free of **defects in materials and workmanship** for a period of twelve (12) months from the date of shipment to the end user. **Warranty does not cover maintenance required due to life.** To make a claim under this limited warranty, customer must ship the entire unit (or the component believed to be defective) to Golden Engineering, post-paid. Golden Engineering assumes no liability for units or components shipped until they are actually in the custody of Golden Engineering, Inc. Provided Golden Engineering, in its sole discretion, is satisfied that the failure is not the result of excessive use, abuse, misuse, accident, modification or improper disassembly or repair, Golden Engineering will provide parts and labor required for the repair. Golden Engineering reserves the right to use reconditioned and remanufactured components that meet original specifications. The unit or component will be return shipped to customer at customer's expense. THIS EXPRESS LIMITED WARRANTY IS IN LIEU OF ALL OTHER WARRANTIES AND GUARANTEES, EITHER EXPRESS OR IMPLIED OR CREATED BY OPERATION OF LAW.

### THE XR200 X-Ray Source is manufactured by:

GOLDEN ENGINEERING, INC.  
PO BOX 185  
CENTERVILLE, IN 47330 USA  
**Phone:** 1-765/855-3493  
**Fax:** 1-765/855-3492  
**WEB:** [www.goldenengineering.com](http://www.goldenengineering.com)

### RETURNING UNIT FOR REPAIR

- **Complete the repair form** at [www.goldenengineering.com/technical.html](http://www.goldenengineering.com/technical.html) and include a copy of the printed form with the repair. If you do not have internet access prior to sending repair then include a letter containing a brief description of the problem, contact name, phone number, and return address.
- Remove battery before shipping the unit.
- Accessories are not required
- Be sure the unit is securely packaged for shipment and wrap in plastic bag if there is an oil leak.
- Ship to address:

**Golden Engineering**  
**6364 Means Road,**  
**Centerville, IN 47330 USA**  
**Phone: 1-765-855-3493**  
**EMAIL: [service@goldenengineering.com](mailto:service@goldenengineering.com)**

**Serial Number:** \_\_\_\_\_

**Delivery Date:** \_\_\_\_\_

## 11.0 SPECIFICATIONS

<b>PHYSICAL DIMENSIONS</b>	
LENGTH	10.69 inches (27.15 cm)
WIDTH	4.26 inches (4.26 cm)
HEIGHT	7.44 inches (18.90 cm)
WEIGHT	13 pounds (5.91 Kg) with battery
<b>X-RAY OUTPUT</b>	
X-ray dose per pulse	3.1 mR/pulse min, measured 12" from source
Pulses per battery charge	4000
Pulses per second	15 (Nominal)
Expected tube life (glass tube)	100,000 pulses
X-ray source size	1/8 " (3mm)
Maximum Photon Energy	150 kVp
X-ray pulse width	60 nanoseconds
<b>ELECTRICAL AND THERMAL CHARACTERISTICS</b>	
Battery voltage	18 volts
Battery type	Nickel Cadmium sub C cells
Battery recharge time	One Hour
Current draw	35 amps @ 13.4 volts
Average X-ray Tube Current	0.5 mA
Temperature range	-10 to 120 degrees F (-23 to 50 degrees C)
Maximum duty cycle	200 pulses every 4 minutes (3000 pulses per hour)
Warm-up	None required

## 12.0 SPARE PARTS AND ACCESSORIES FOR THE XR200

<b>ITEM</b>	<b>PART NUMBER</b>
Thumbwheel Key	2002000
Flat key	5951040
Tube	2200020
DeWalt® Battery 18v PLUS DW9096	1800103
DeWalt® Battery Charger (110V) DW9116	1800156
DeWalt® Battery Charger (220V) DE9108	1800157
Remote Cable	1809013
Tripod Mount	2008010
Handle – Left Side	4000210
Handle – Right Side	4000200
Carrying case (holds X-ray, 2 batteries, charger, cable)	1701640